



TW-12
(Vertical Installation)
Installation Guide

TW-12

(Vertical Install.)
Installation Guide

- Table of Contents -

Section	Page
<i>General Notes</i>	<i>i</i>
<i>Panel Details</i>	<i>1</i>
<i>Clips</i>	<i>2</i>
<i>Panel Closures</i>	<i>3</i>
<i>Closure Installation</i>	<i>4</i>
<i>Base</i>	<i>5</i>
<i>Sill</i>	<i>6</i>
<i>End Wall</i>	<i>7</i>
<i>Outside Corner</i>	<i>8</i>
<i>Inside Corner</i>	<i>9</i>
<i>Soffit (Front)</i>	<i>10</i>
<i>Soffit (Back)</i>	<i>11</i>
<i>End Splice (w/Trim)</i>	<i>12</i>
<i>Parapet</i>	<i>13</i>
<i>Door/Window (Head)</i>	<i>14</i>
<i>Door/Window (Jamb)</i>	<i>15</i>
<i>Door/Window (Sill)</i>	<i>16</i>
<i>Wall Penetration (3D)</i>	<i>17</i>
<i>Wall Penetration</i>	<i>18</i>
<i>Rigid Insulation</i>	<i>19</i>

General Notes

The attached installation details are intended to be a design aid and do not depict all situations. Modifications are the responsibility of the designer/user and should take into account climate conditions such as wind and snow, governing code requirements, and the actual usage and maintenance of the structure.

Applications:

TW-12 can be utilized as a wall panel installed in the vertical or horizontal orientation. It shall not be utilized for roof applications. TW-12 can be used over solid substrates or over spaced supports. This installation guide depicts clip attached panels installed using flush mounted clips. Details for direct fastened panels or clip attached panels using standoff clips would be similar.

Flashings:

Where possible, flashings should be lapped away from prevailing winds. Certain flashings should be supported if it is likely that equipment (ladder, etc.) will be used against them. Check with AEP Span any time you intend to specify a prefinished flashing in a gauge or finish different than the TW-12. It is good practice to specify that all flashings be of the same material (gauge, color, finish) as the roof panels to ensure long-term durability. Field-painted flashings rarely equal the durability and colorfastness of factory baked-on paint systems. The enclosed details have minimized the use of exposed fasteners where possible. The edges of flashings have also been shown hemmed to strengthen and to minimize the exposure of cut edges.

Flashing design and fabrication is generally the responsibility of the contractor. For convenience, we have provided some typical flashing drawings on our website at <http://www.aepspan.com/roof/prodDetailad08.html?id=35>. Applicable TW-12 flashing part numbers are referenced within this installation guide. Note that flashing shapes and dimensions may vary greatly based on project requirements. Installation details and flashings referenced within are for general design guidance only.

Condensation, Insulation, & Ventilation:

It is the designer's responsibility to determine the need and composition of condensation control materials including insulation and vapor retarders, as well as ventilation requirements. Metal wall products are susceptible to condensation and its control should be carefully considered.

Thermal Movement:

Both panels and flashings must allow for thermal movement (expansion and contraction) of the materials, especially where long lengths are used. Appropriate gaps or provisions must be provided to accommodate thermal movement.

Oil Canning:

Flat metal surfaces often display waviness commonly referred to as 'oil canning'. This can be caused by variations in raw material, processing variations, product handling, or variations in the installation substrate. Oil canning is a characteristic, not a defect, of panels manufactured from light-gauge metal. To reduce potential for oil canning, substrates should not deviate from a flat plane more than 1/4 inch in 20 feet, or 1/8 inch in 5 feet. Oil canning is not a cause for panel rejection. Additional technical information is available upon request.

References:

The Sheet Metal and Air Conditioning Contractors' National Association Inc. (SMACNA) manual is an excellent reference for sheet metal contractors. It's guidelines for underlayments, gutter and downspout size requirements, and expansion/contraction of metals and flashing joints should be followed.

Technical Assistance:

Contact your AEP Span Sales Representative for additional information.



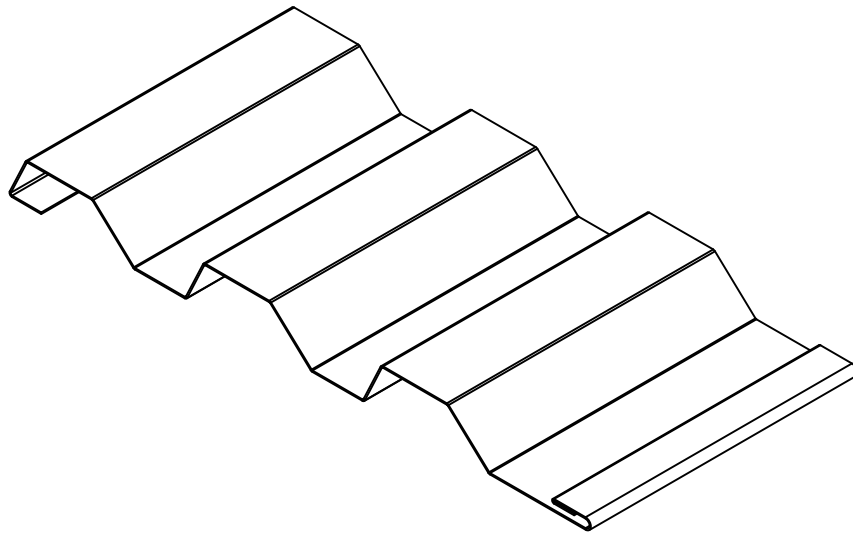

TW-12

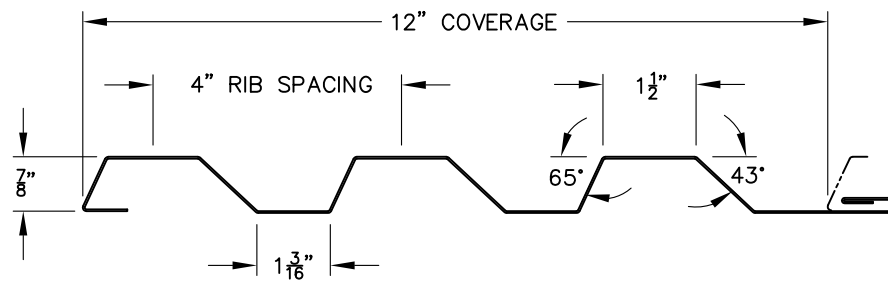

PANEL INTERLOCK OPTIONS



DIRECT FASTENED
('D' P/N SUFFIX)



CLIP ATTACHED
('C' P/N SUFFIX)

MATERIAL:

STEEL: 22 & 24GA (20GA NON-STD.)

AVAILABLE LENGTHS: 5'-20'



TW-12
VERTICAL INSTALL.

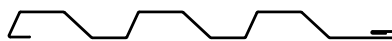

PANEL DETAILS

TWV-01

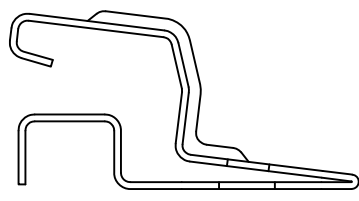
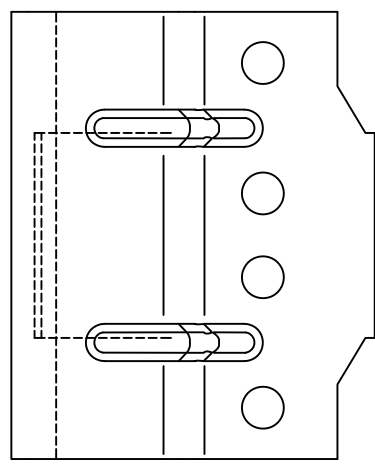
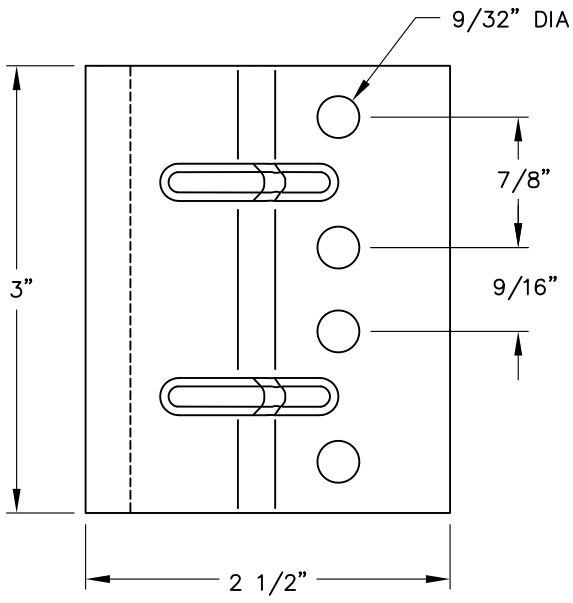

FLUSH CLIP
P/N: #WALLCLP

STANDOFF CLIP
P/N: #WALLCLP0.5

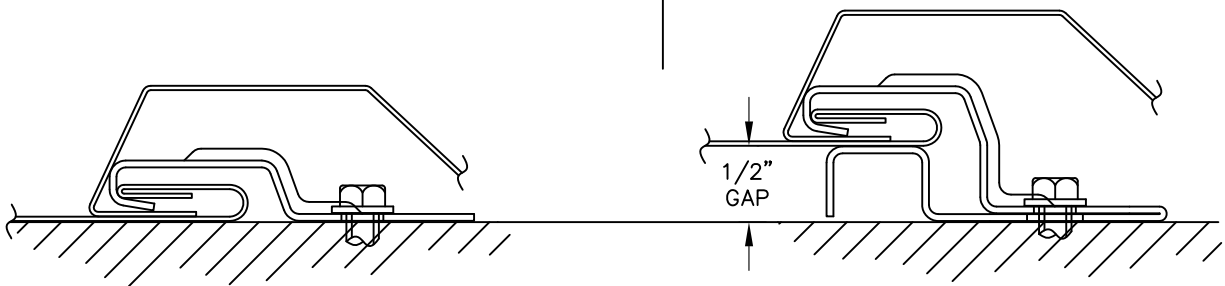

INSTALLED POSITION



TW-12
VERTICAL INSTALL.

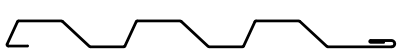

CLIPS

TWV-02

CLTW-12BP

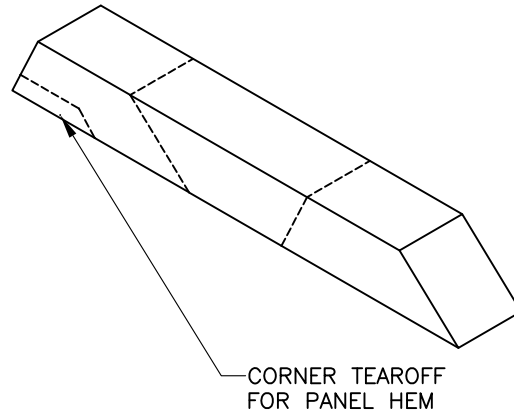

BOTTOM SIDE CLOSURE

CORNER TEAROFF
FOR PANEL HEM

TEAROFF PERFORATED PLUG
SECTIONS TO FILL PANEL
REVEALS AS REQUIRED

CLTW-12TP

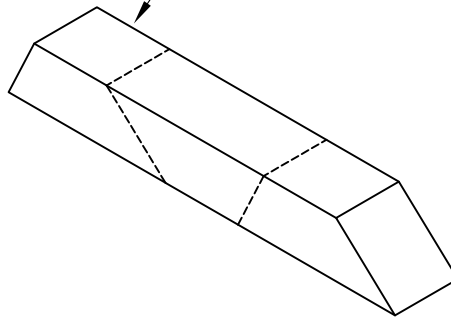

TOP SIDE CLOSURE

NOTE: APPLICATIONS UTILIZING STANDOFF CLIP ALSO REQUIRE
UNIVERSAL CLOSURE STRIP (AEP #CLEM1x19.68 OR EQUIV.) TO
SEAL OFF ADDITIONAL 1/2" PANEL-TO-SUBSTRATE GAP.



TW-12
VERTICAL INSTALL.



PANEL CLOSURES

TWV-03

TOP SIDE CLOSURE
INSTALLATION

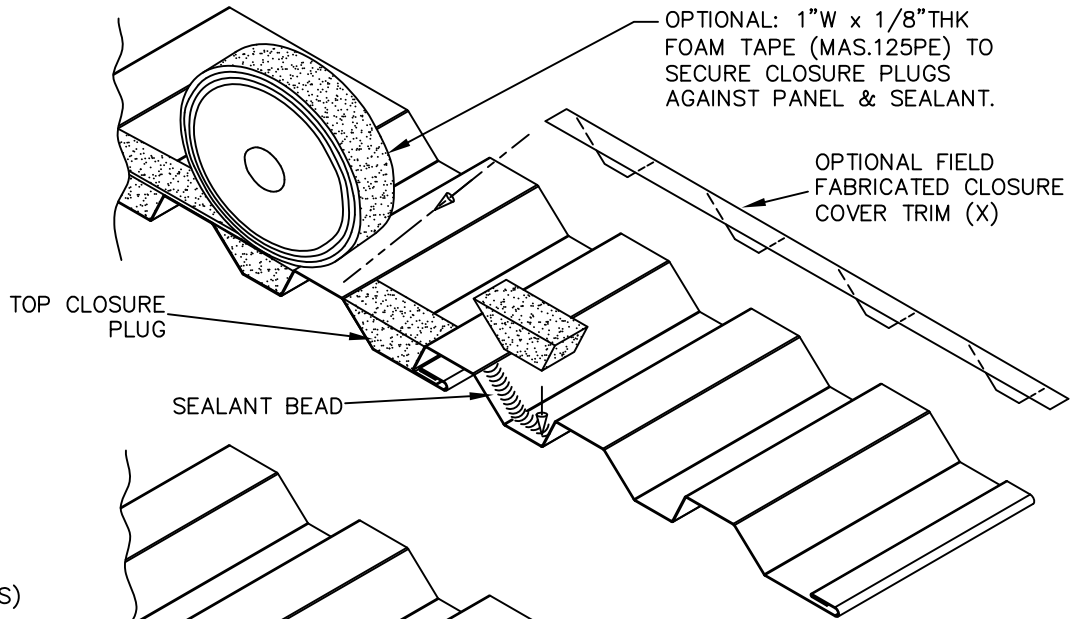

BOTTOM SIDE CLOSURE
INSTALLATION
(FLUSH MOUNTED PANELS)

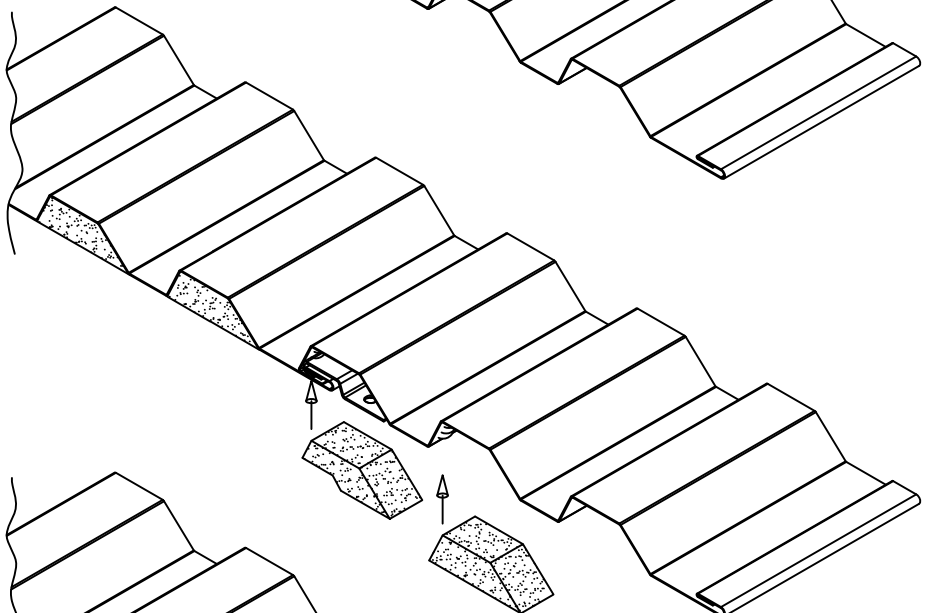

BOTTOM SIDE CLOSURE
INSTALLATION
(PANELS WITH STANDOFF CLIP)

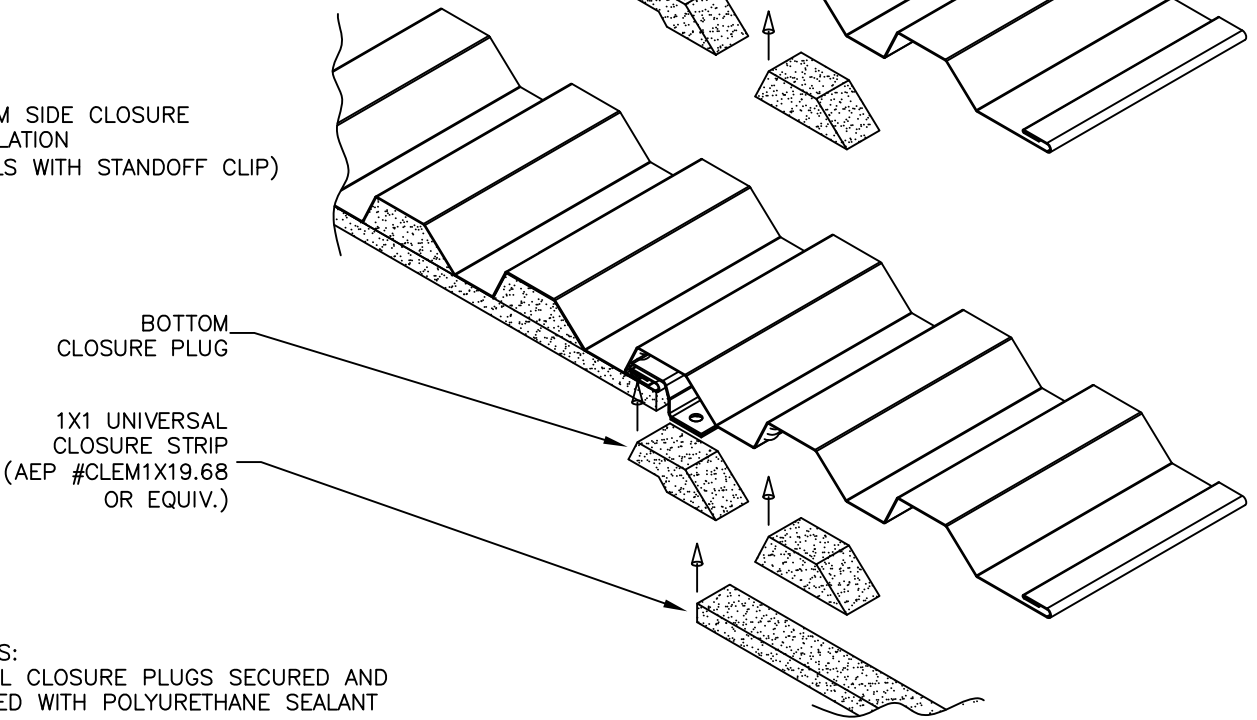

NOTES:
 - ALL CLOSURE PLUGS SECURED AND
 SEALED WITH POLYURETHANE SEALANT
 (X) - NOT BY AEP SPAN



TW-12
 VERTICAL INSTALL.

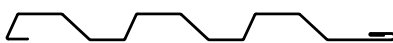

CLOSURE
 INSTALLATION

TWV-04

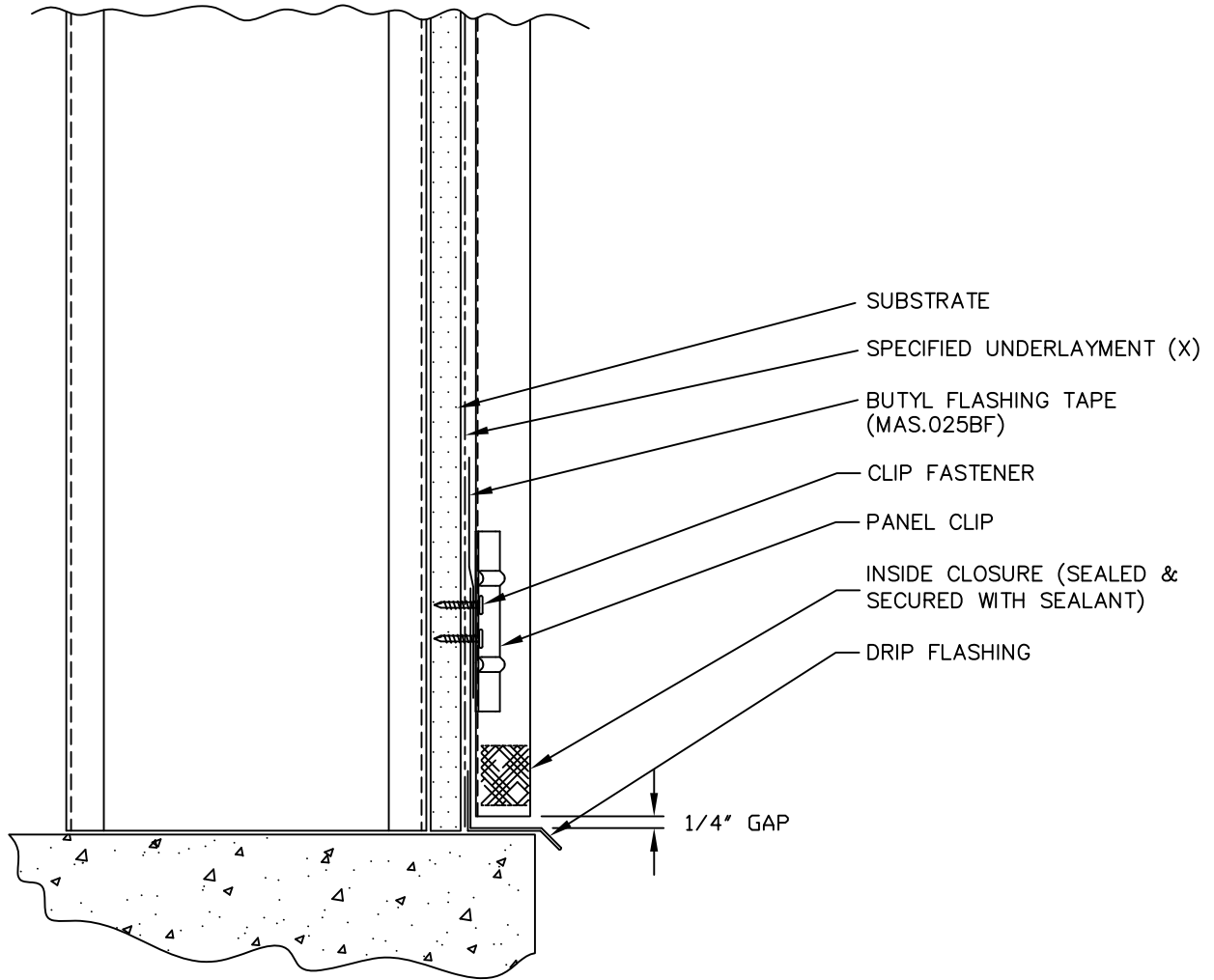
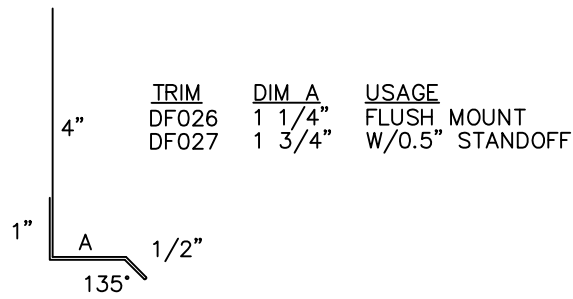

(X) - NOT BY AEP SPAN



TW-12
VERTICAL INSTALL.

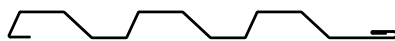

BASE

TWV-05

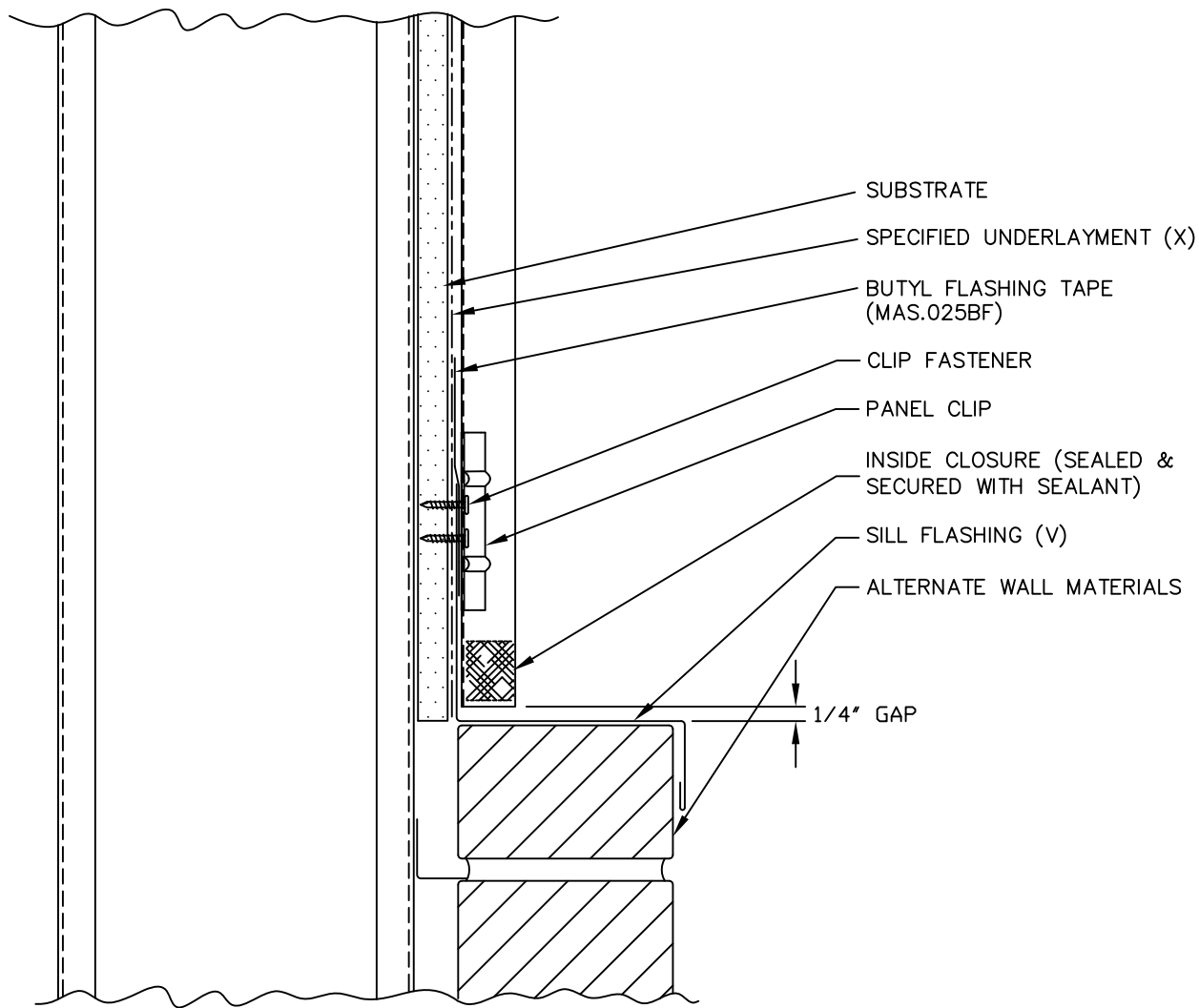

(X) - NOT BY AEP SPAN
 (V) - DIMENSIONS VARY BASED ON PROJECT CONDITIONS



TW-12
 VERTICAL INSTALL.

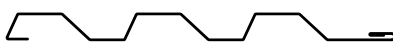

SILL

TWV-06

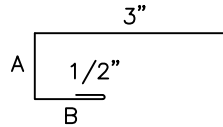

TRIM	DIM A	DIM B	USAGE
JT108	1 1/8"	1 1/8"	FLUSH MOUNT
JT112	1 5/8"	1 1/2"	W/0.5" STANDOFF

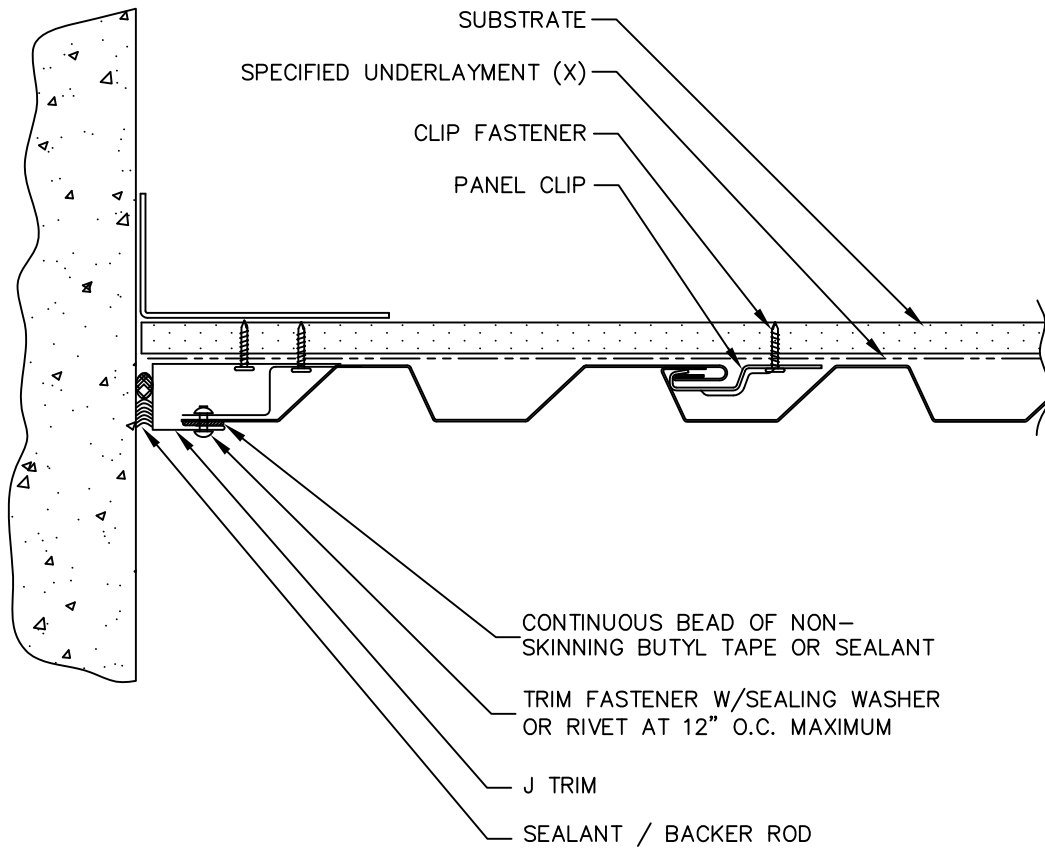

(X) - NOT BY AEP SPAN



TW-12
VERTICAL INSTALL.

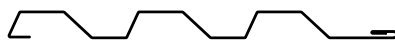

END WALL

TWV-07

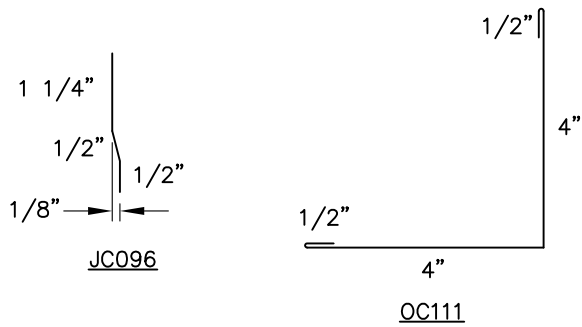

TRIM	DIM. A	USAGE
ZC225	7/8"	FLUSH MOUNT
ZC228	1 3/8"	W/0.5" STANDOFF

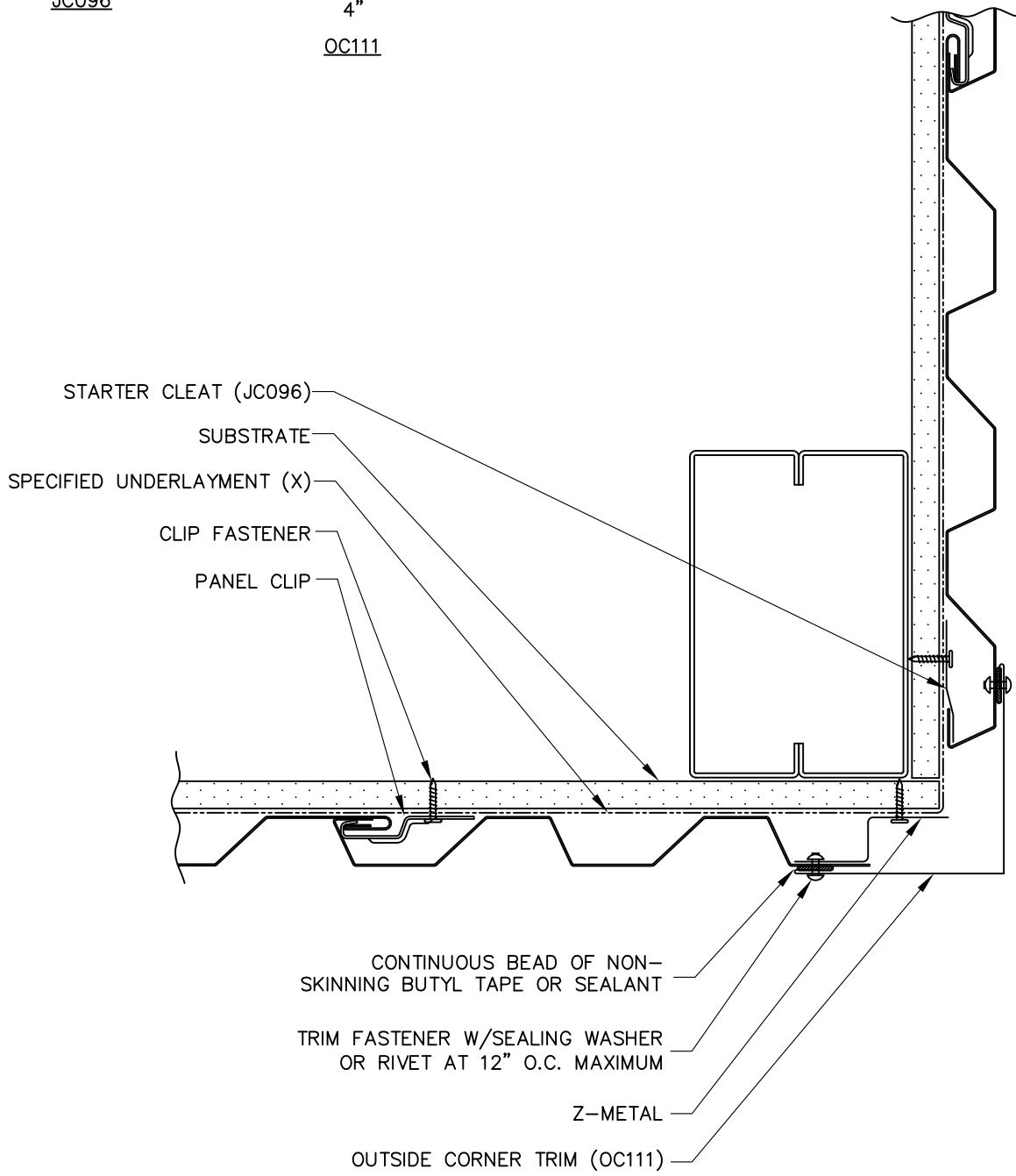

(X) - NOT BY AEP SPAN



TW-12
VERTICAL INSTALL.

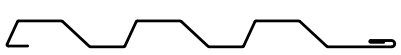

OUTSIDE CORNER

TWV-08

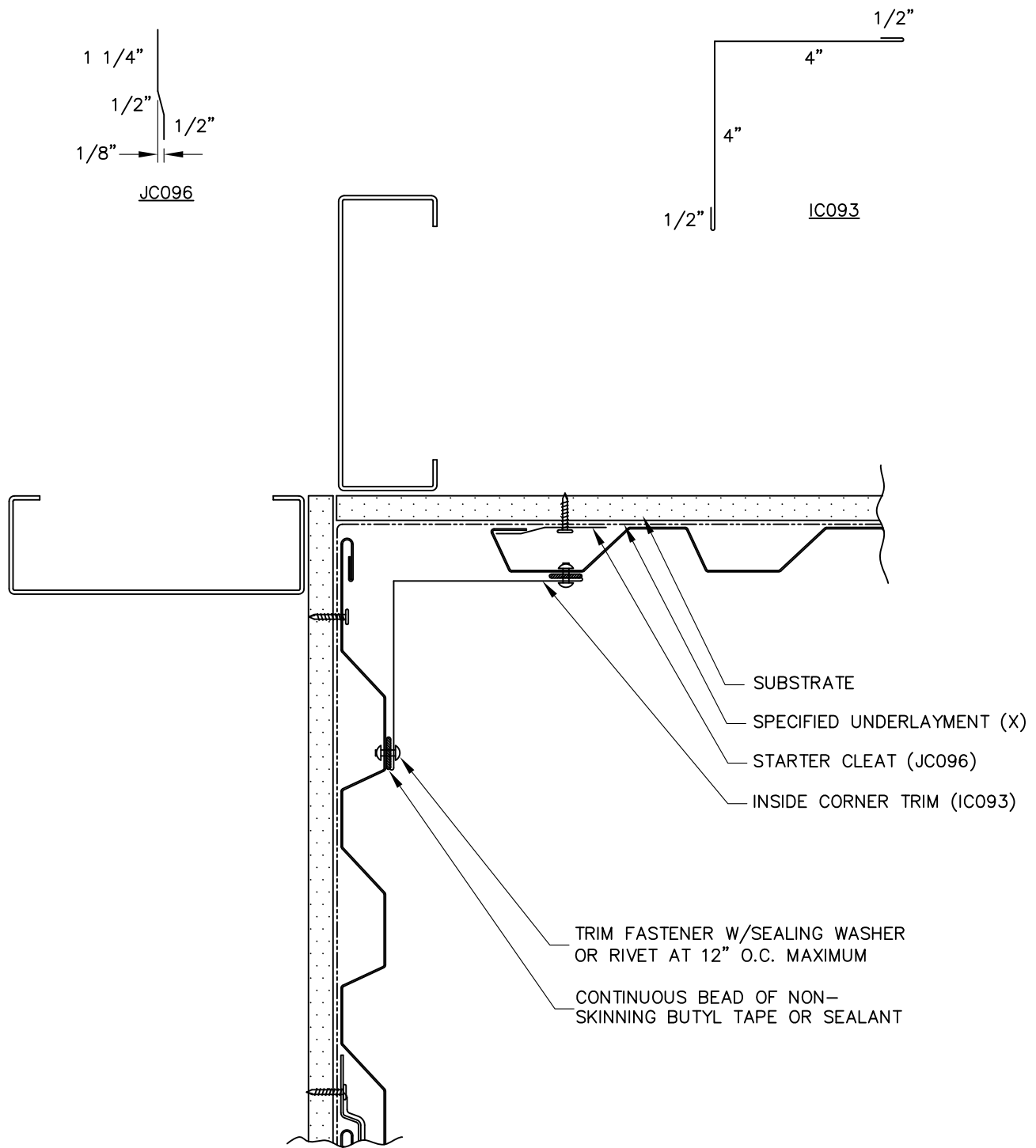

(X) – NOT BY AEP SPAN



TW-12
VERTICAL INSTALL.

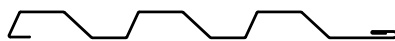

INSIDE CORNER

TWV-09

TRIM	DIM. A	USAGE
DF032	1 1/8"	FLUSH MOUNT
DF033	1 5/8"	W/0.5" STANDOFF

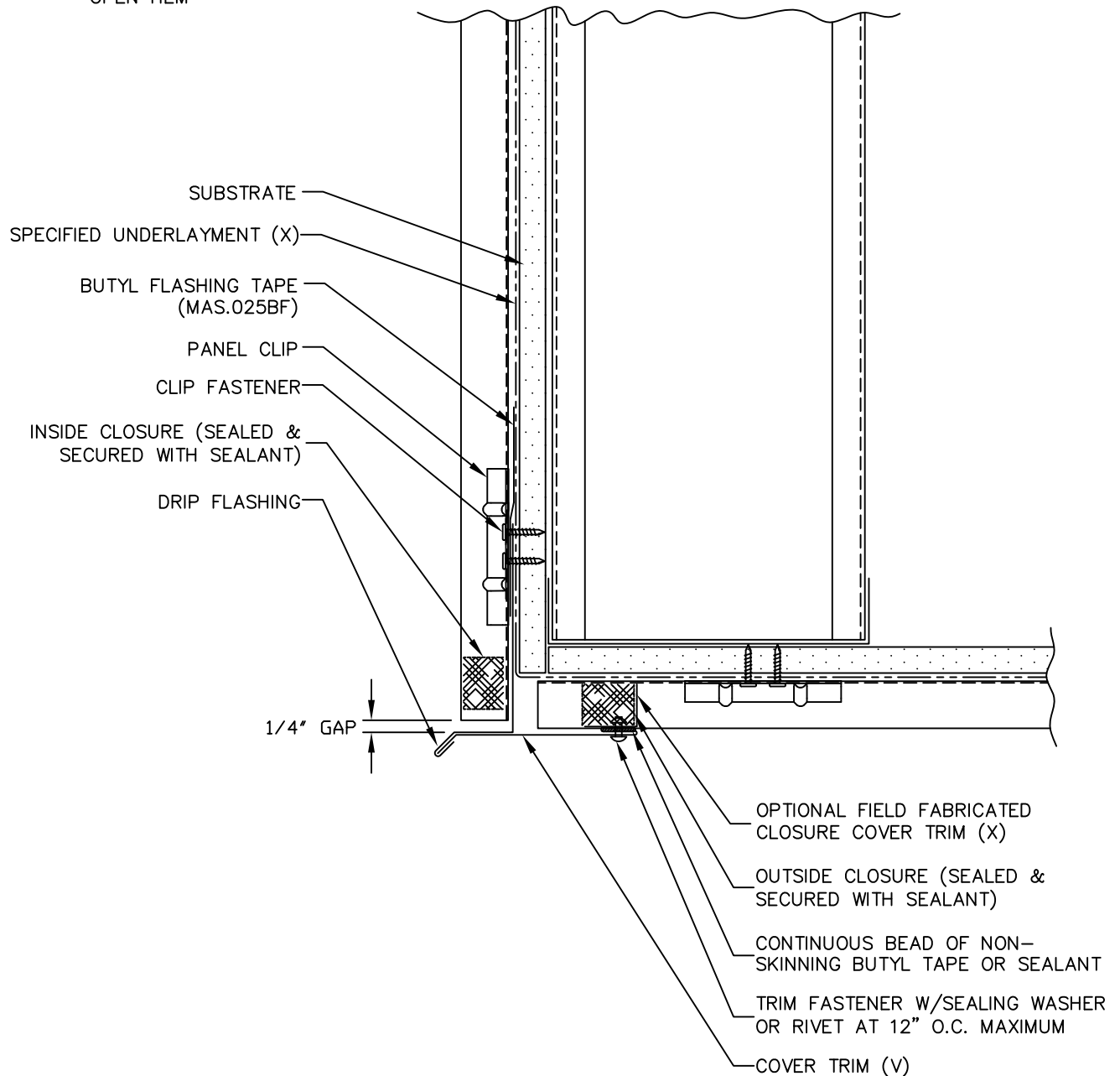
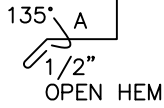
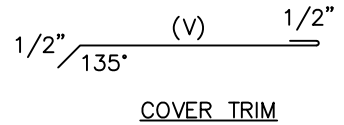

(X) - NOT BY AEP SPAN
(V) - DIMENSIONS VARY BASED ON PROJECT CONDITIONS



TW-12
VERTICAL INSTALL.

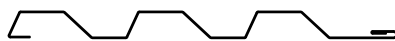

SOFFIT (FRONT)

TWV-10

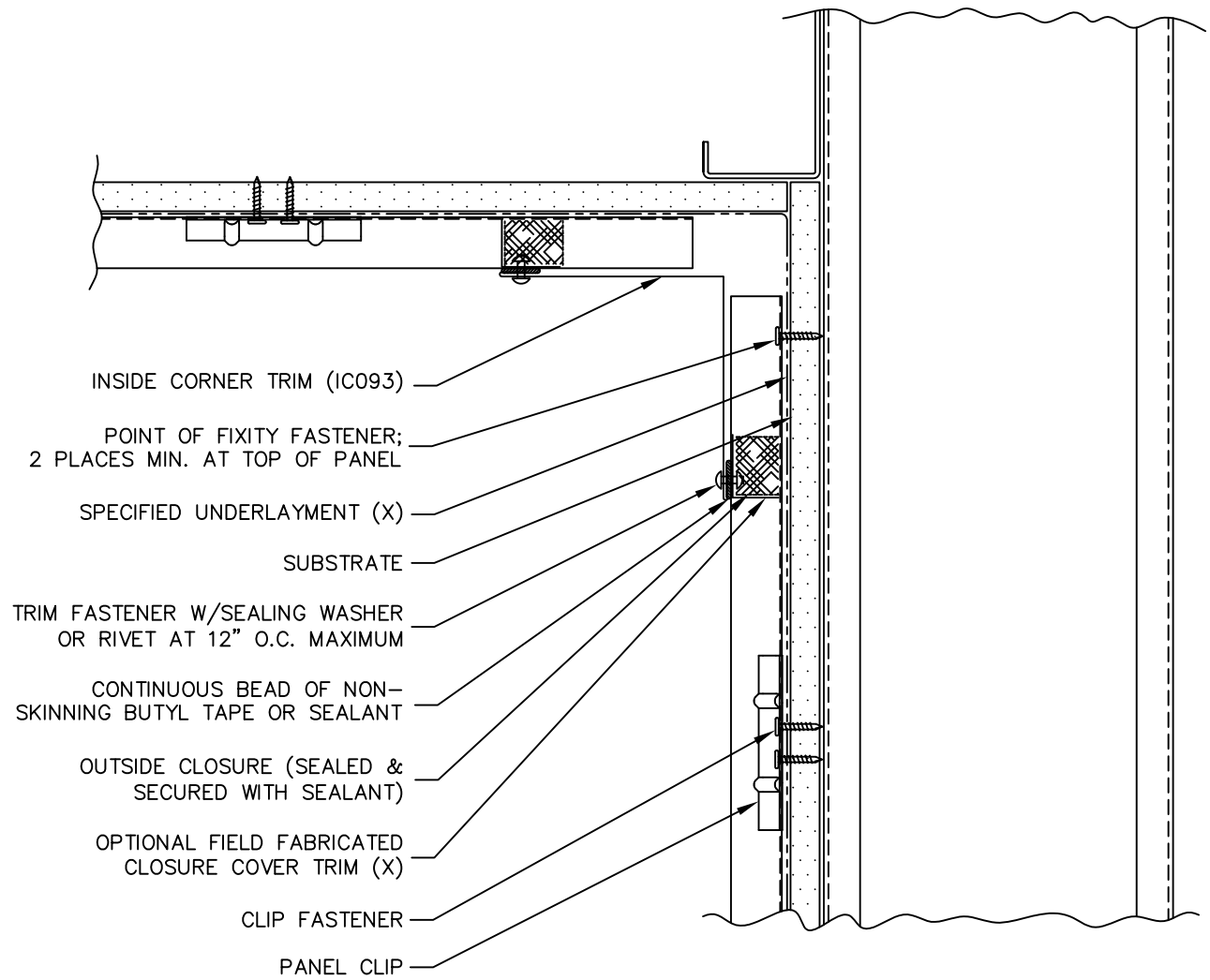
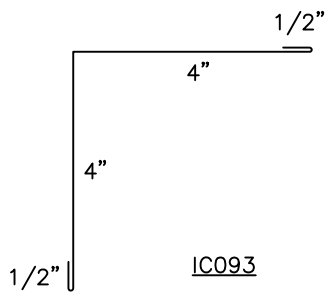

- INSIDE CORNER TRIM (IC093)
- POINT OF FIXITY FASTENER;
2 PLACES MIN. AT TOP OF PANEL
- SPECIFIED UNDERLAYMENT (X)
- SUBSTRATE
- TRIM FASTENER W/SEALING WASHER
OR RIVET AT 12" O.C. MAXIMUM
- CONTINUOUS BEAD OF NON-
SKINNING BUTYL TAPE OR SEALANT
- OUTSIDE CLOSURE (SEALED &
SECURED WITH SEALANT)
- OPTIONAL FIELD FABRICATED
CLOSURE COVER TRIM (X)
- CLIP FASTENER
- PANEL CLIP

(X) - NOT BY AEP SPAN



TW-12
VERTICAL INSTALL.

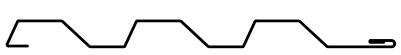

SOFFIT (BACK)

TWV-11

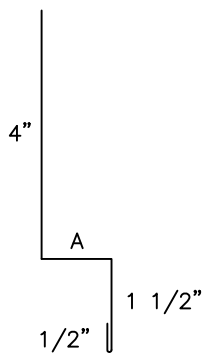

TRIM	DIM A	USAGE
HT092	1 1/8"	FLUSH MOUNT
HT103	1 5/8"	W/0.5" STANDOFF

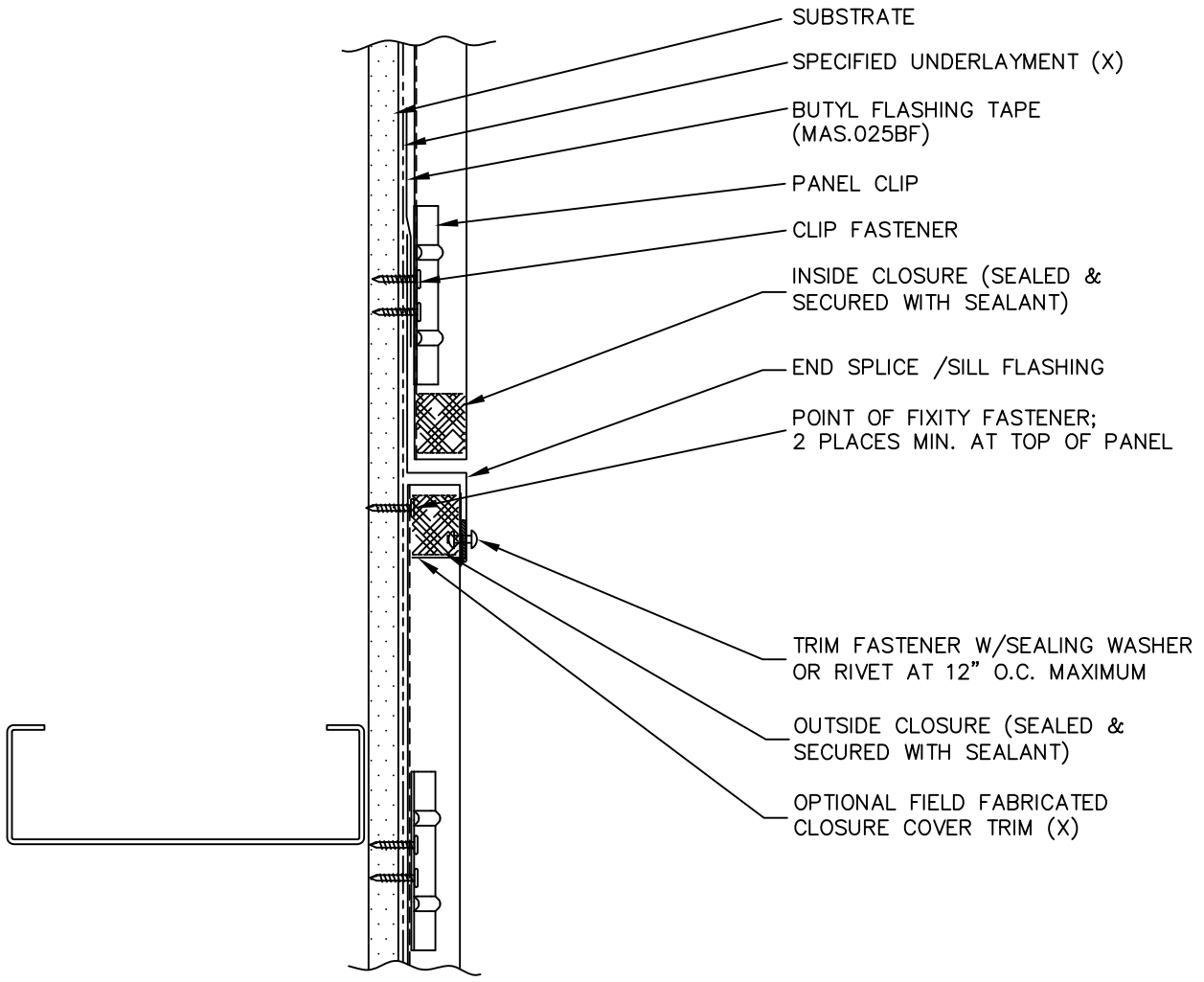

(X) - NOT BY AEP SPAN



TW-12
VERTICAL INSTALL.

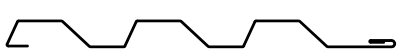

END SPLICE (W/TRIM)

TWV-12

1 1/2"
 135°
 5/8"

IC209

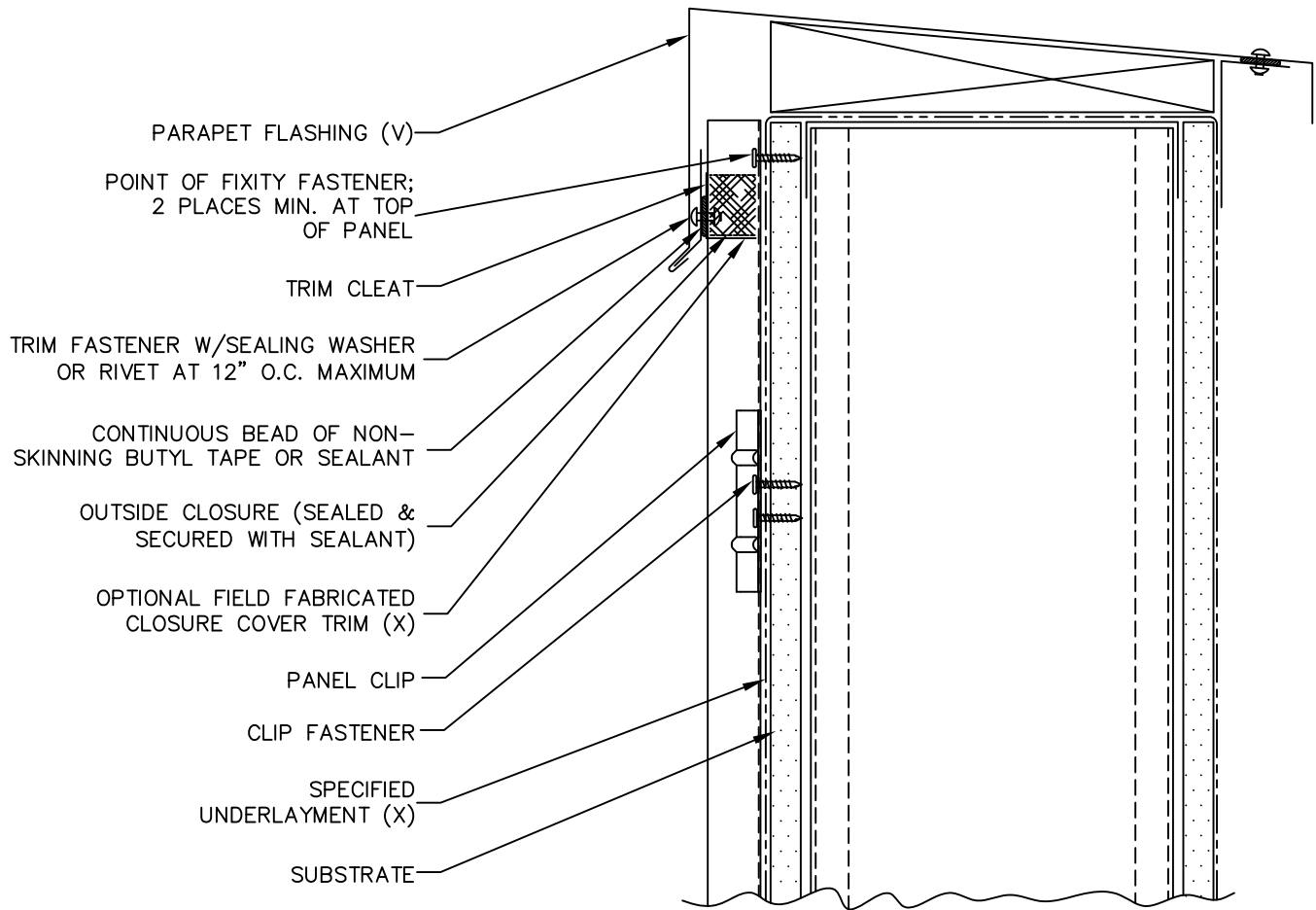

(X) - NOT BY AEP SPAN
 (V) - DIMENSIONS VARY BASED ON PROJECT CONDITIONS



TW-12
 VERTICAL INSTALL.

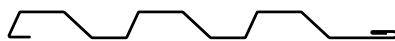

PARAPET

TWV-13

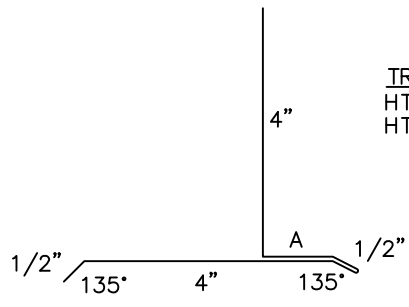

TRIM	DIM A	USAGE
HT093	1 1/8"	FLUSH MOUNT
HT102	1 5/8"	W/0.5" STANDOFF

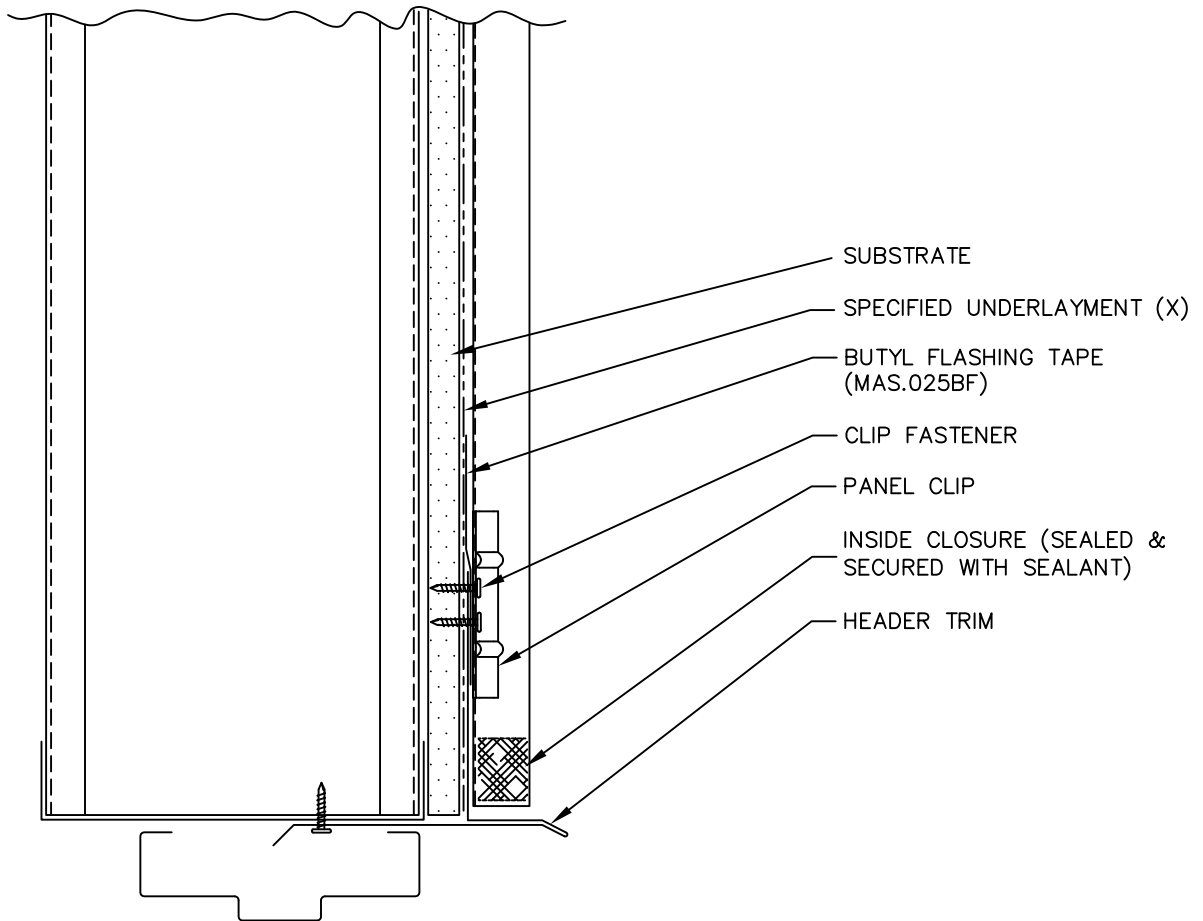

(X) - NOT BY AEP SPAN



TW-12
VERTICAL INSTALL.

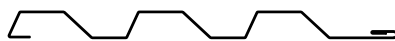

DOOR / WINDOW
(HEAD)

TWV-14

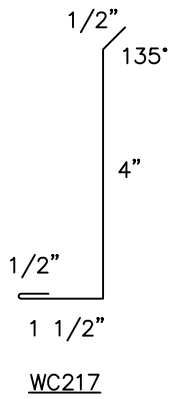

TRIM	DIM A	USAGE
ZC225	7/8"	FLUSH MOUNT
ZC228	1 3/8"	W/0.5" STANDOFF

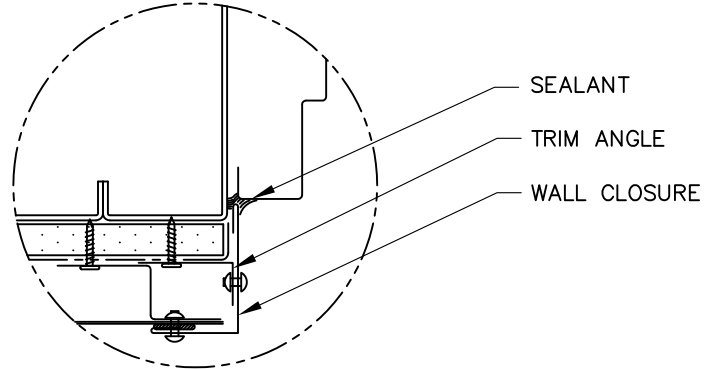

ALTERNATE DETAIL

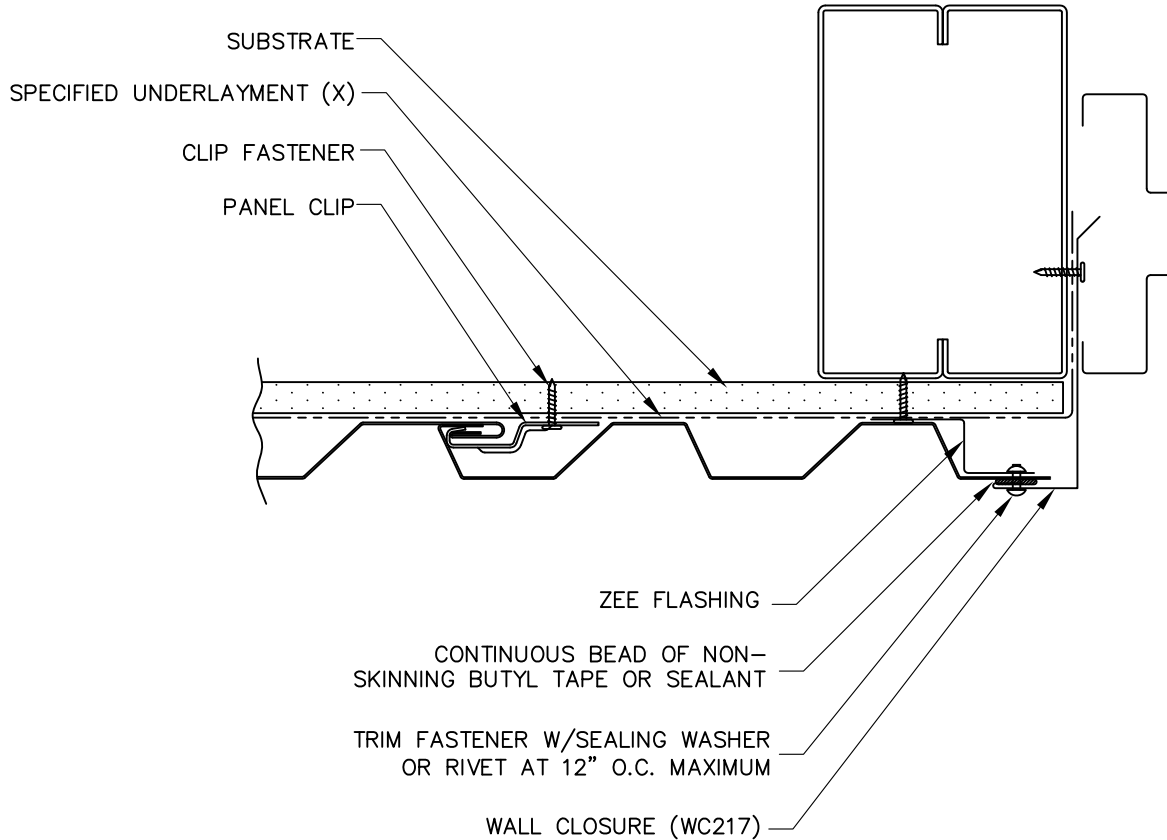

(X) - NOT BY AEP SPAN



TW-12
VERTICAL INSTALL.

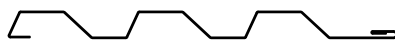

DOOR / WINDOW
(JAMB)

TWV-15

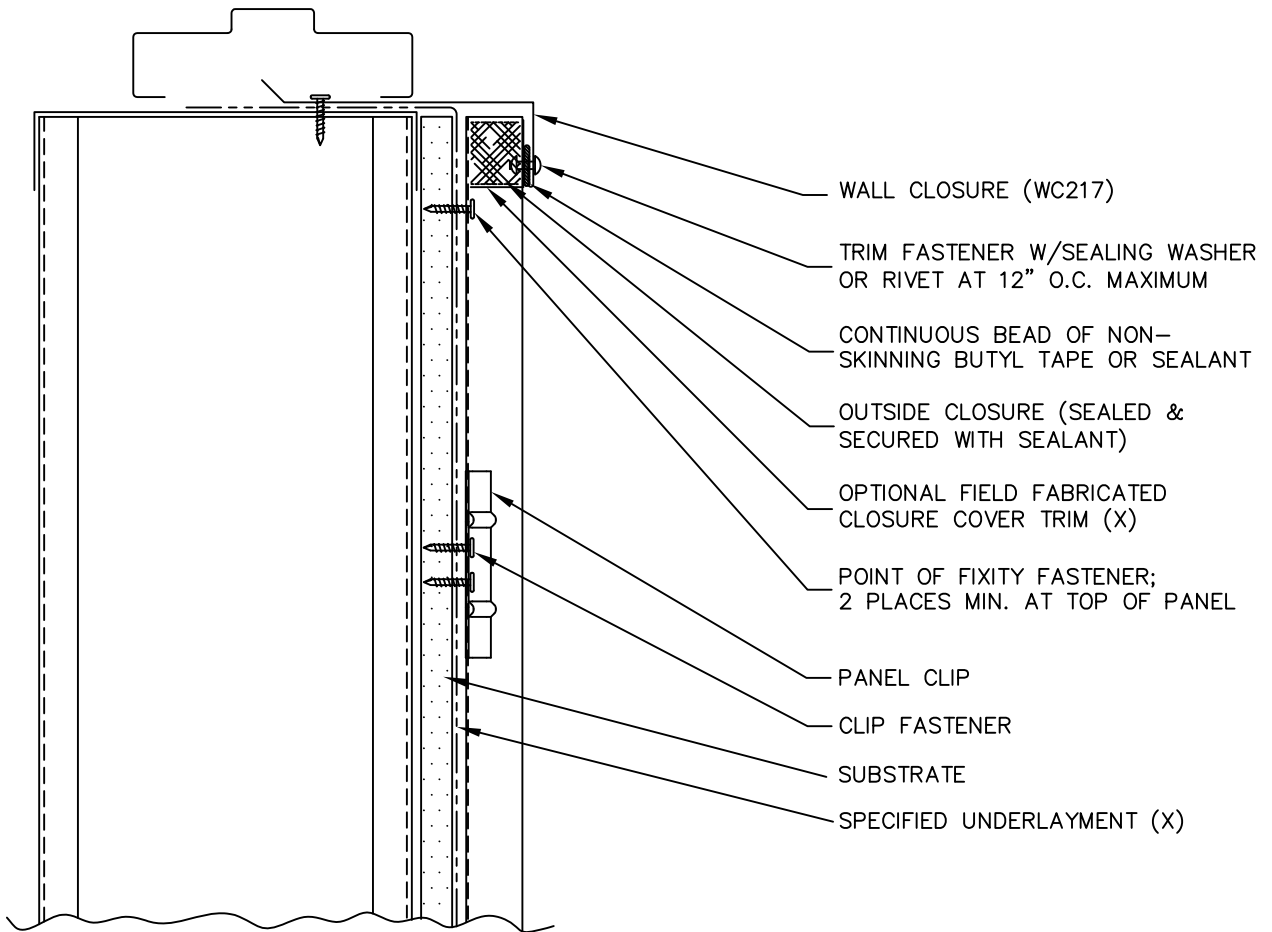
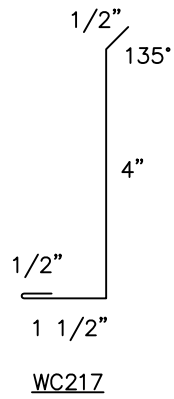

(X) - NOT BY AEP SPAN



TW-12
VERTICAL INSTALL.

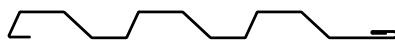

DOOR / WINDOW
(SILL)

TWV-16

DRIP FLASHING
 TRIM FASTENER W/SEALING
 WASHER, OR RIVET
 SEALANT
 OVERLAP UPPER/LOWER
 FLASHINGS
 WALL PENETRATION

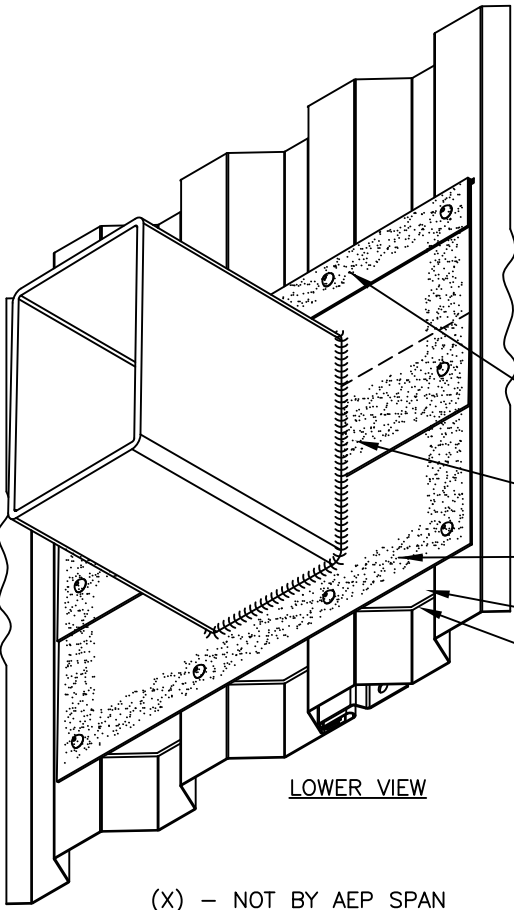
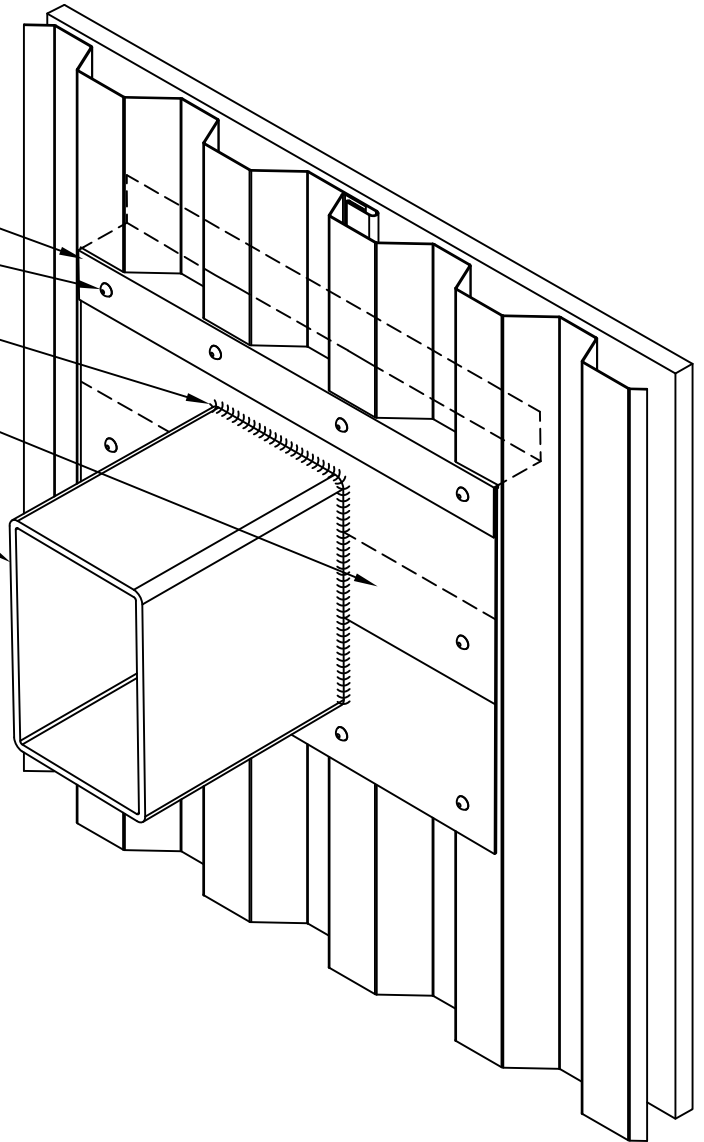

SEAL PERIMETER OF FLASHINGS AND
 ALL TRIM OVERLAPS WITH A
 CONTINUOUS BEAD OF NON-
 SKINNING BUTYL TAPE OR SEALANT
 OPTIONAL FIELD FABRICATED
 CLOSURE COVER TRIM (X)
 OUTSIDE CLOSURE (SEALED &
 SECURED WITH SEALANT)

LOWER VIEW

(X) - NOT BY AEP SPAN



TW-12
 VERTICAL INSTALL.

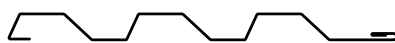

WALL PENETRATION (3D)

TWV-17

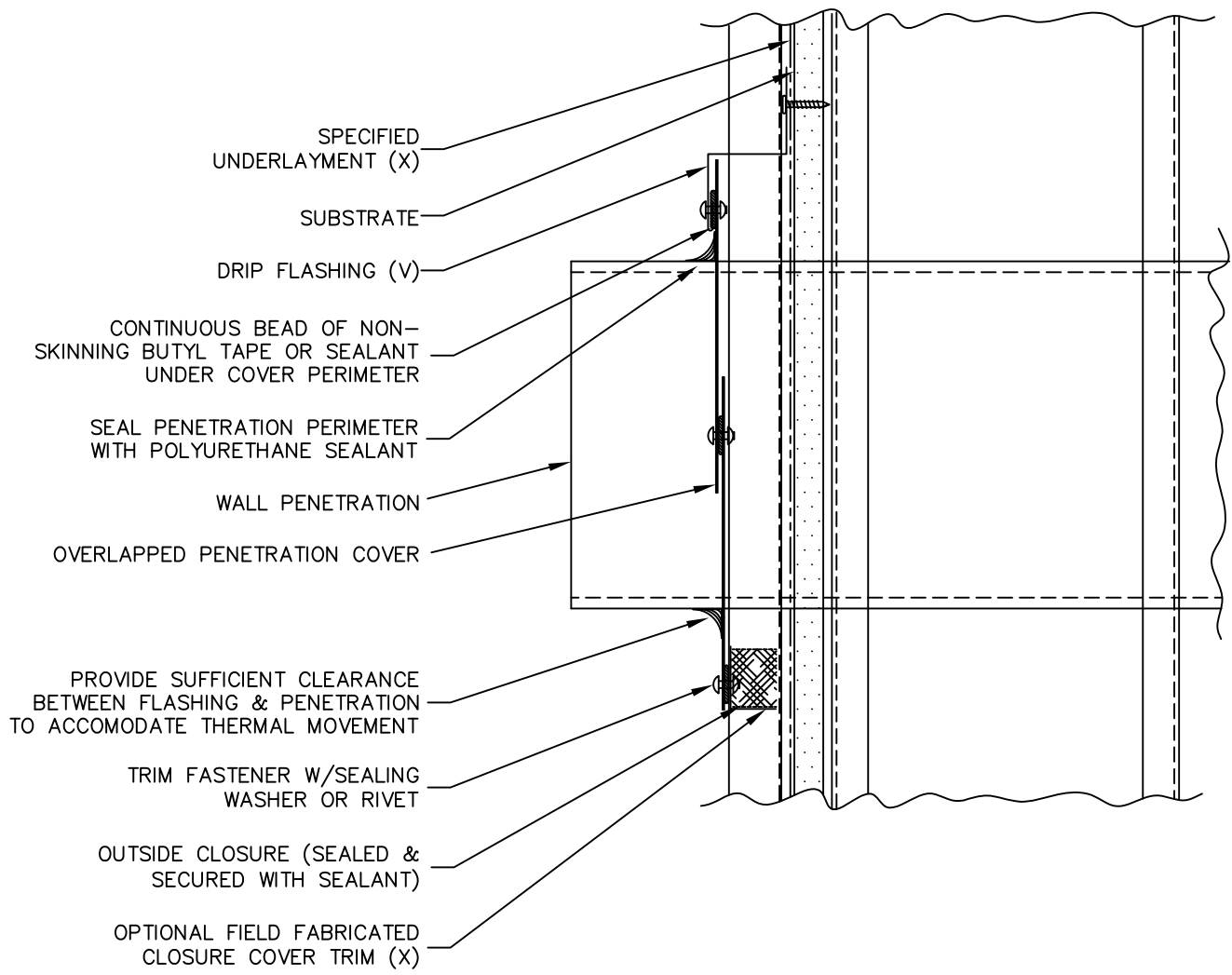

(X) - NOT BY AEP SPAN
 (V) - DIMENSIONS VARY BASED ON PROJECT CONDITIONS



TW-12
 VERTICAL INSTALL.

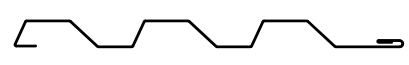

WALL PENETRATION

TWV-18

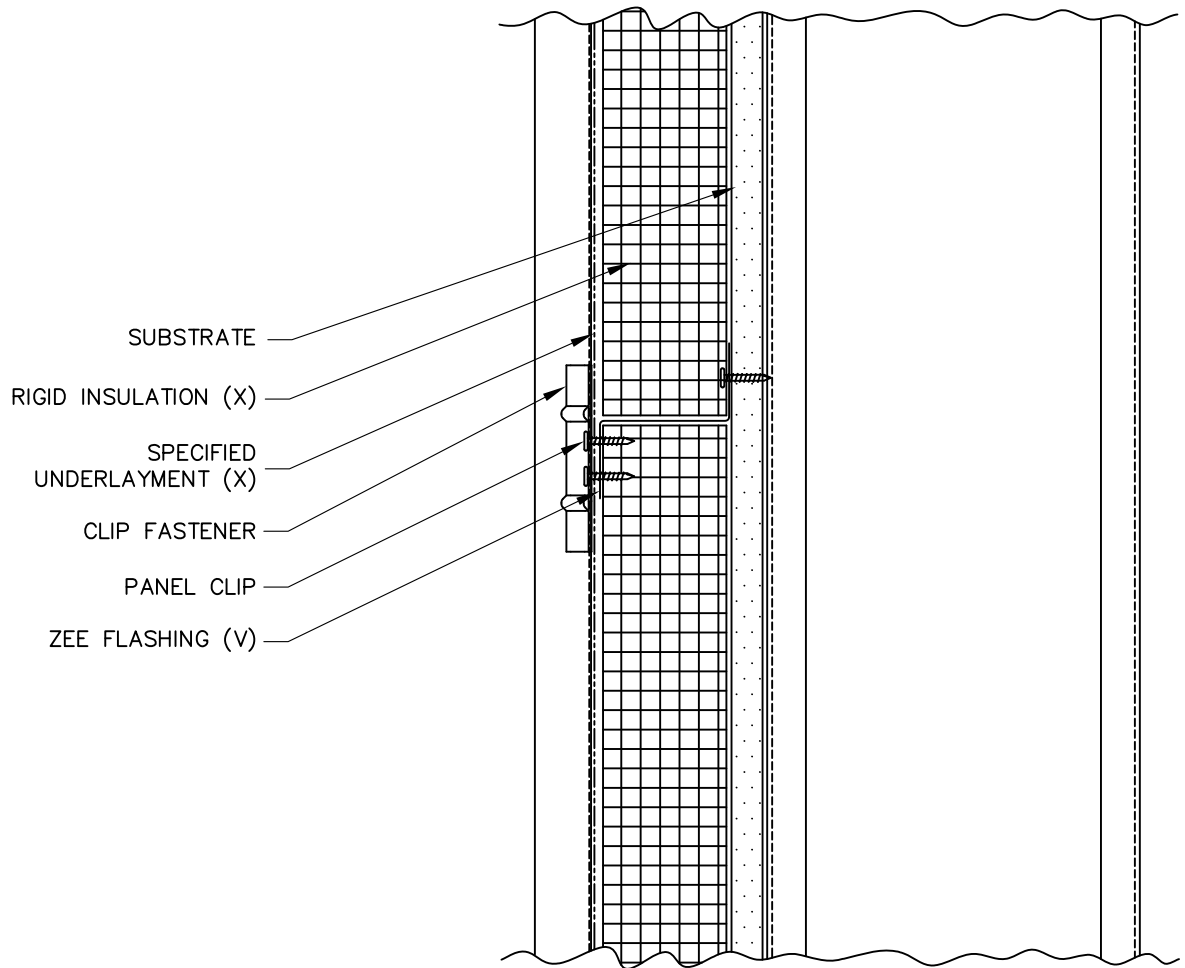

(X) - NOT BY AEP SPAN
 (V) - DIMENSIONS AND GAGE VARY BASED ON PROJECT CONDITIONS



TW-12
 VERTICAL INSTALL.

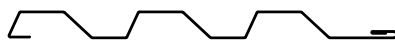

RIGID INSULATION

TWV-19

MANUFACTURING FACILITY:

Anchorage, Alaska

2441 Cinnabar Loop
Anchorage, AK 99507
Alaska Customer Service: 904-267-3004

Fontana, California

10905 Beech Avenue
Fontana, CA 92337

CORPORATE HEADQUARTERS:

ASC Profiles LLC

2110 Enterprise Boulevard
West Sacramento, CA 95691

CUSTOMER SERVICE:

800-733-4955

Visit us at:

www.aepspan.com

